

20
24

ADVANCE
HARDWARE
COLLECTION

Door Levers

ADVANCE

D O O R L E V E R S



INTRODUCTION .



7 factories



190,000



3,000 employees



ISO9001/ISO14001/BSCI/ICS/
SEDEX/GSV/SCAN/IWAY/FSC/LCMP
(ITS/SGS/BV/UL/TUV)



In-house production



Spare capacity

Salt Spray Test:
96 hours

Endurance Test:
200,000 times

INDEX



8	Aluminium Door Levers
28	Stainless Steel Door Levers
54	Zinc Door Levers
83	Rosettes
92	Plates
106	Finishes





Lever No.
A001
Item No.
ZQ03A001

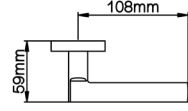

Lever No.
A002
Item No.
ZQ03A002

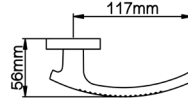

www.advance-hardware.com

www.advance-hardware.com



Lever No.
A003
Item No.
ZQ03A003

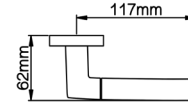

Lever No.
A004
Item No.
ZQ05A004

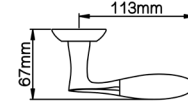



Lever No.
A005
Item No.
ZQ09A005

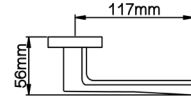

Lever No.
A006
Item No.
ZQ05A006

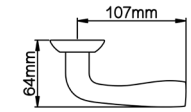

www.advance-hardware.com

www.advance-hardware.com

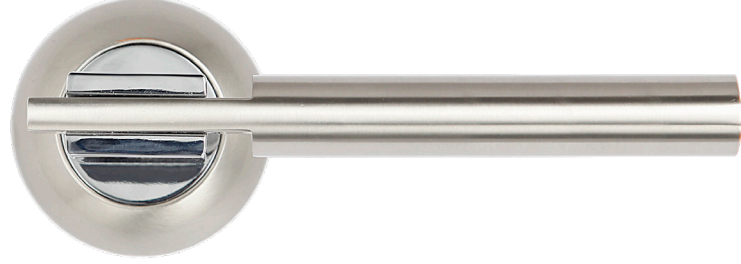

Lever No.
A007
Item No.
ZQ05A007

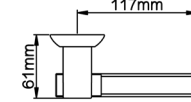

Lever No.
A008
Item No.
ZQ05A008

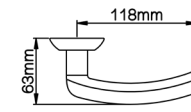



Lever No.
A009
Item No.
ZQ05A009

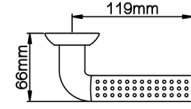

Lever No.
A010
Item No.
ZQ03A010

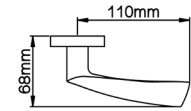

www.advance-hardware.com

www.advance-hardware.com



Lever No.
A011
Item No.
ZQ05A011

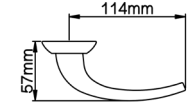

Lever No.
A012
Item No.
ZQ03A012

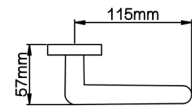



Lever No.
A013
Item No.
ZQ05A013

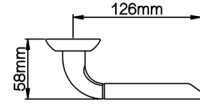

Lever No.
A014
Item No.
ZQ05A014

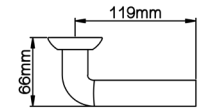

www.advance-hardware.com

www.advance-hardware.com



Lever No.
A016
Item No.
ZQ05A016

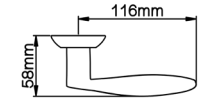

Lever No.
A017
Item No.
ZQ03A017

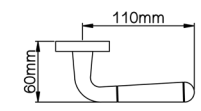



Lever No.
A018
Item No.
ZQ03A018

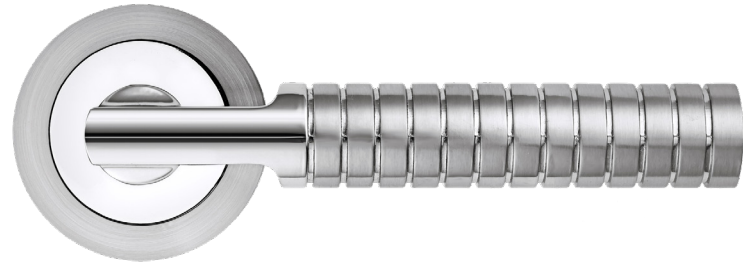
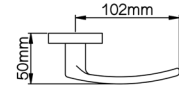

Lever No.
A022
Item No.
ZQ03A022

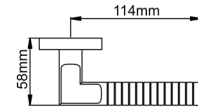

www.advance-hardware.com

www.advance-hardware.com



Lever No.
A035
Item No.
ZQ03A035

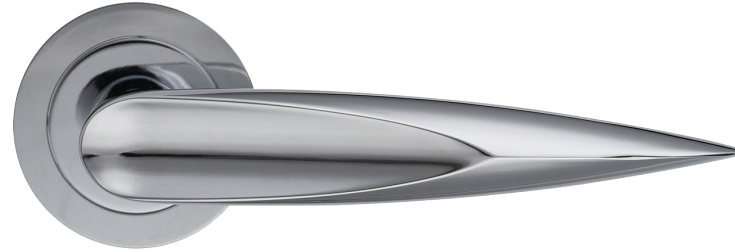
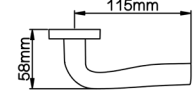

Lever No.
A036
Item No.
ZQ03A036

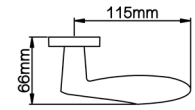



Lever No.
A037
Item No.
ZQ36A037

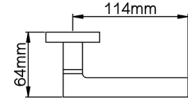

Lever No.
A038
Item No.
ZQ05A038

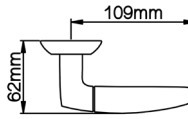

www.advance-hardware.com

www.advance-hardware.com



Lever No.
A047
Item No.
ZQ03A047

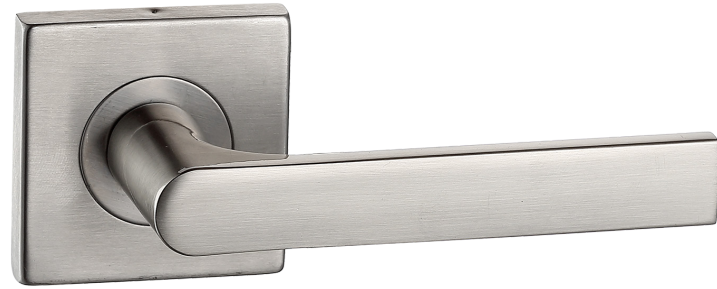
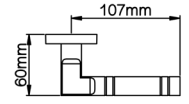

Lever No.
A067
Item No.
SQ21A067

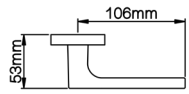



Lever No.
A069
Item No.
ZQ08A069

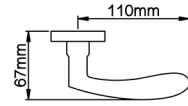

Lever No.
A070
Item No.
ZQ08A070

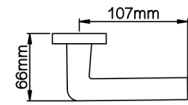

www.advance-hardware.com

www.advance-hardware.com



Lever No.
A078
Item No.
ZQ35A078

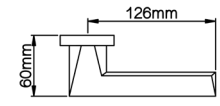

Lever No.
A079
Item No.
ZQ35A079

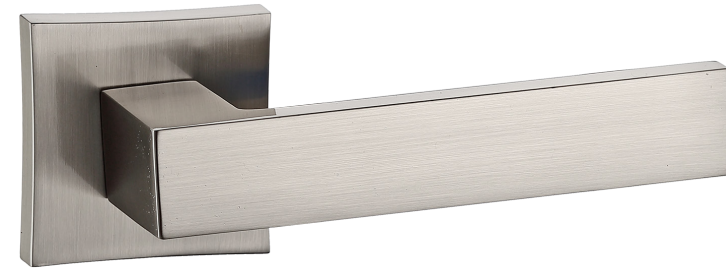
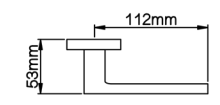



Lever No.
A082
Item No.
ZQ08A082

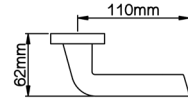

Lever No.
A083
Item No.
ZQ35A083

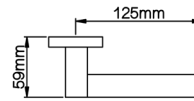
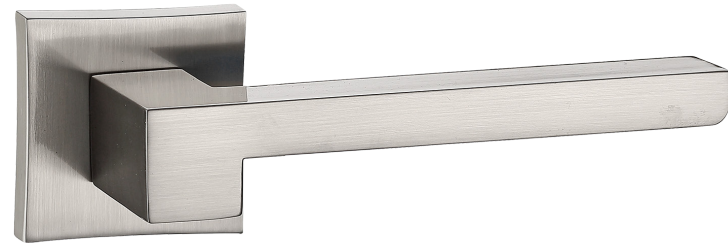

www.advance-hardware.com

www.advance-hardware.com



Lever No.
A084
Item No.
ZQ08A084

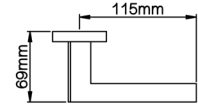

Lever No.
A093
Item No.
ZQ62A093

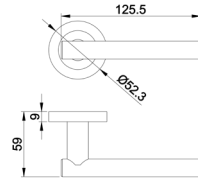



Lever No.
A094

Item No.
ZQ62A094

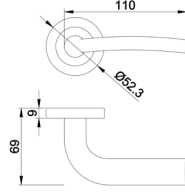

Lever No.
A095

Item No.
ZQ62A095

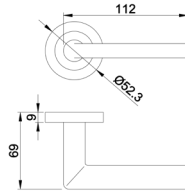

www.advance-hardware.com

www.advance-hardware.com



Lever No.
AQ91

Item No.
AQ91AL153

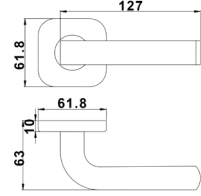

www.advance-hardware.com



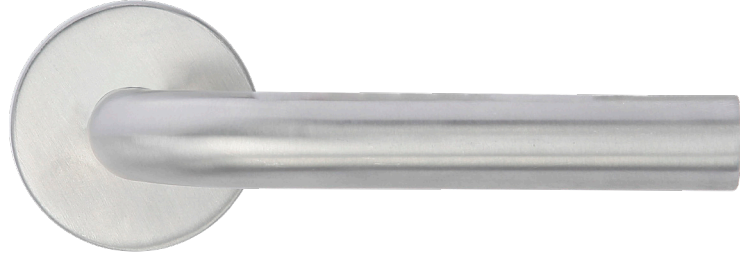

Lever No. S002
Item No. SQ02S002

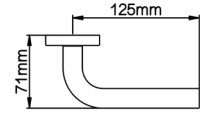

Lever No. S003
Item No. SQ02S003

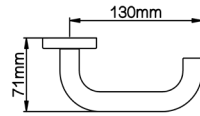

www.advance-hardware.com

www.advance-hardware.com



Lever No. S004
Item No. SQ02S004

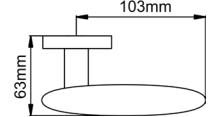

Lever No. S005
Item No. SQ02S005

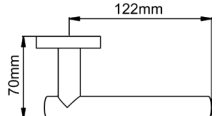



Lever No.
S006

Item No.
SQ02S006

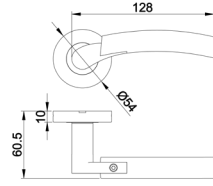

Lever No.
S010

Item No.
SQ02S010

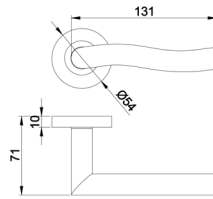

www.advance-hardware.com

www.advance-hardware.com



Lever No.
S011

Item No.
SQ02S011

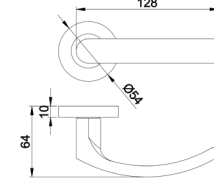

Lever No.
S012

Item No.
SQ02S012

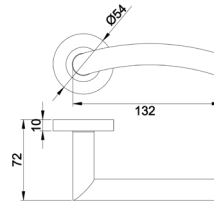

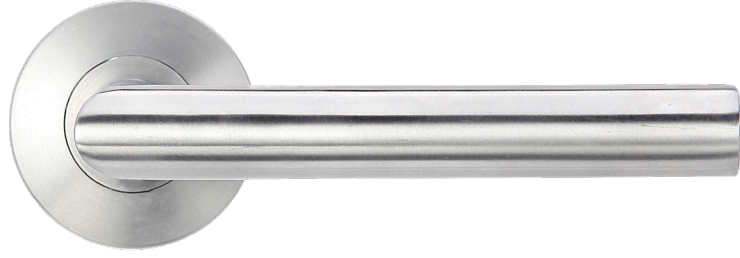

Lever No.
S013
Item No.
SQ02S013

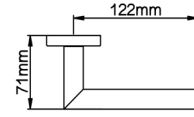

Lever No.
S014
Item No.
SQ02S014

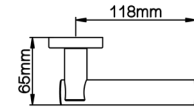

www.advance-hardware.com

www.advance-hardware.com



Lever No.
S015
Item No.
SQ02S015

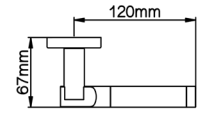

Lever No.
S016
Item No.
SQ21S016

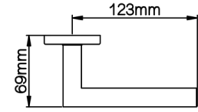
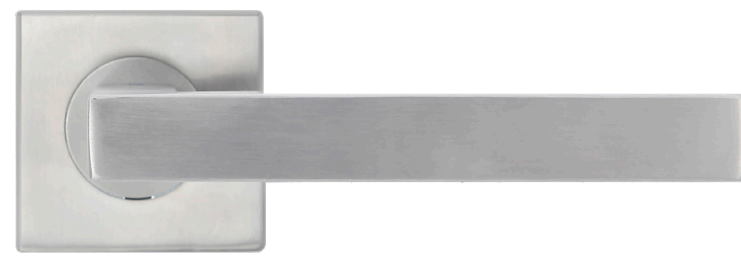



Lever No.
B010

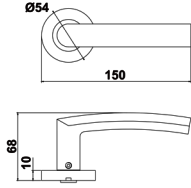

Lever No.
B024

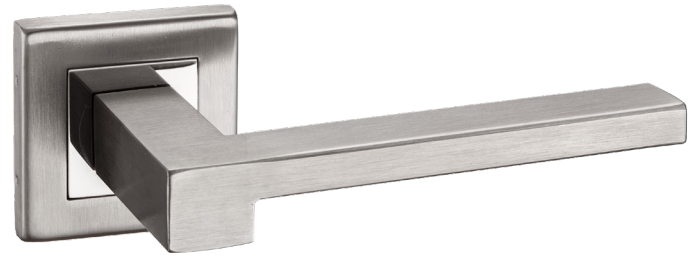
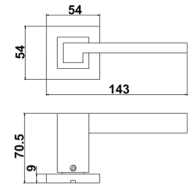

www.advance-hardware.com

www.advance-hardware.com



Lever No.
B101

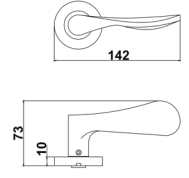

Lever No.
B103

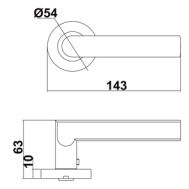



Lever No.
B104

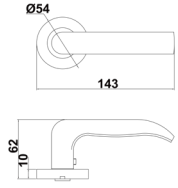

Lever No.
B105P

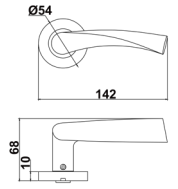

www.advance-hardware.com

www.advance-hardware.com



Lever No.
B106

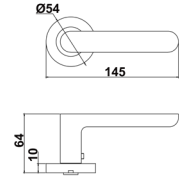

Lever No.
B107

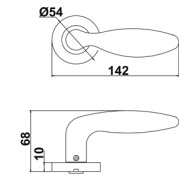



Lever No.
B108

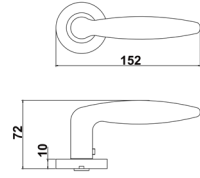

Lever No.
B109

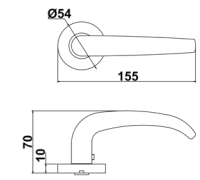

www.advance-hardware.com

www.advance-hardware.com



Lever No.
B110

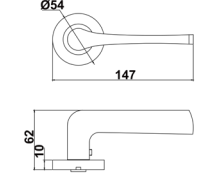

Lever No.
B111

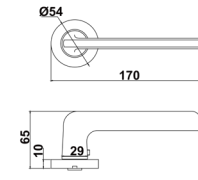



Lever No.
B113

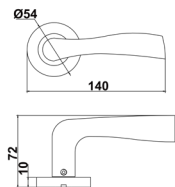

Lever No.
B114

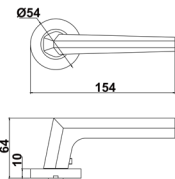

www.advance-hardware.com

www.advance-hardware.com



Lever No.
B115

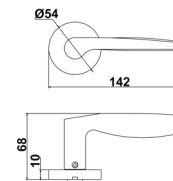

Lever No.
B116

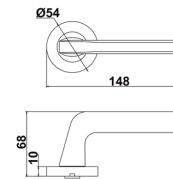



Lever No.
B117

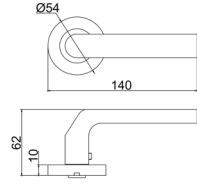

Lever No.
B119

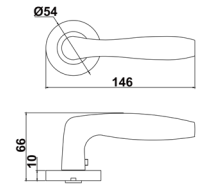

www.advance-hardware.com

www.advance-hardware.com



Lever No.
B121

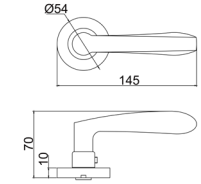

Lever No.
B125

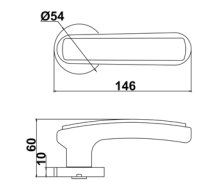



Lever No.
B126

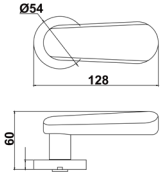

Lever No.
B128

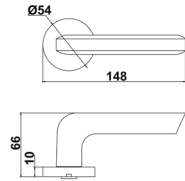

www.advance-hardware.com

www.advance-hardware.com



Lever No.
B132

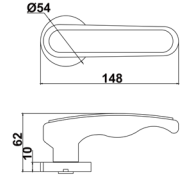

Lever No.
B135

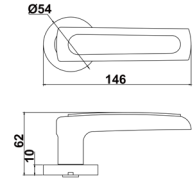



Lever No.
B136

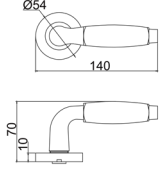

Lever No.
B138

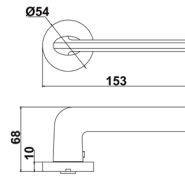

www.advance-hardware.com

www.advance-hardware.com



Lever No.
B139

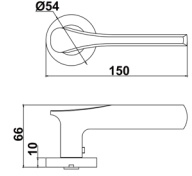

Lever No.
B140

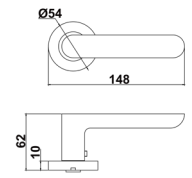



Lever No.
B141

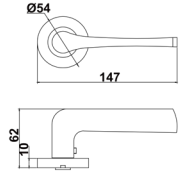

Lever No.
B142

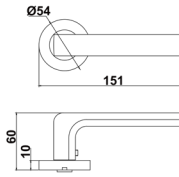

www.advance-hardware.com

www.advance-hardware.com



Lever No.
B143

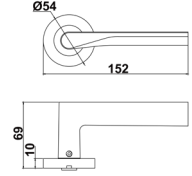

Lever No.
B145

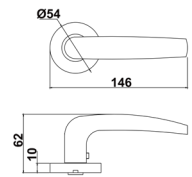



Lever No.
S009
Item No.
SD08S009

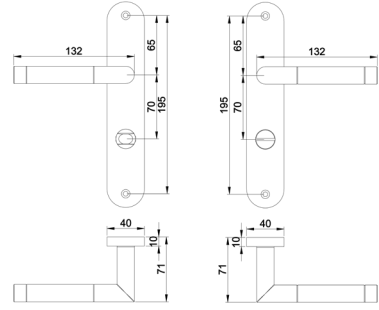

Lever No.
S012
Item No.
SB08S012

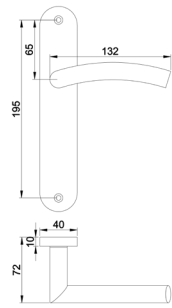

www.advance-hardware.com

www.advance-hardware.com



Lever No.
S020
Item No.
SB09S020

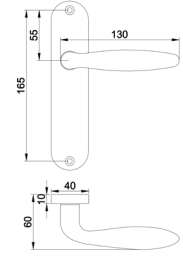

Lever No.
S021
Item No.
SD11S021

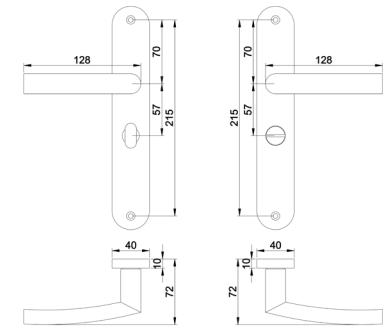



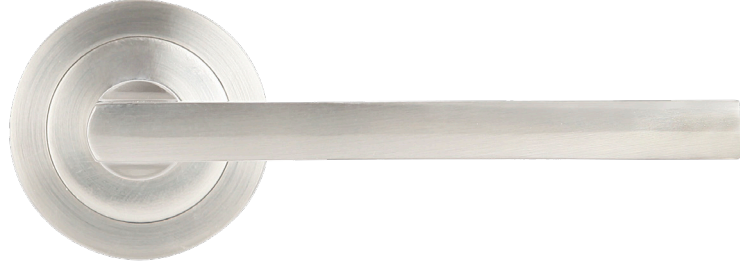

Lever No.
Z001
Item No.
ZQ03Z001

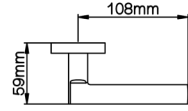

Lever No.
Z002
Item No.
ZQ03Z002

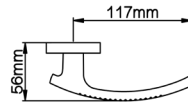

www.advance-hardware.com

www.advance-hardware.com



Lever No.
Z003
Item No.
ZQ03Z003

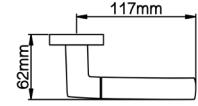

Lever No.
Z004
Item No.
ZQ03Z004

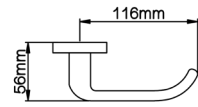
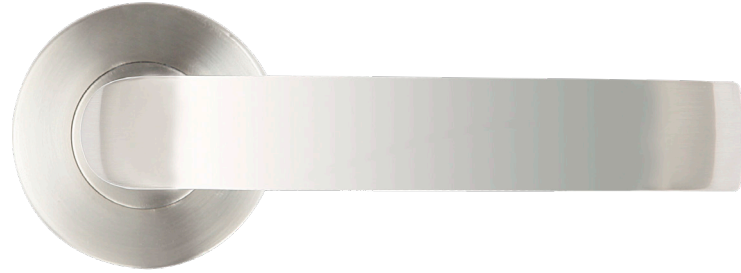

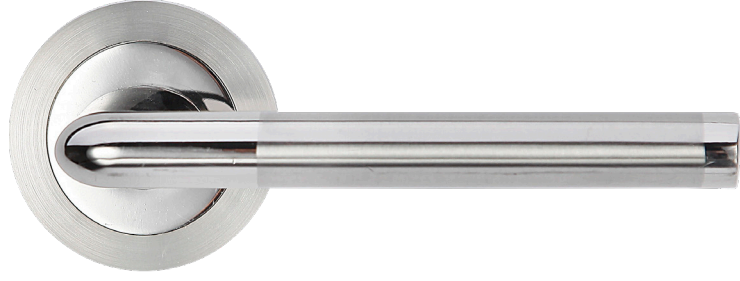

Lever No.
Z005

Item No.
ZQ03Z005

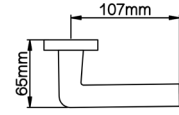

Lever No.
Z006

Item No.
ZQ03Z006

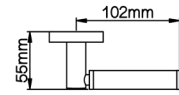

www.advance-hardware.com

www.advance-hardware.com

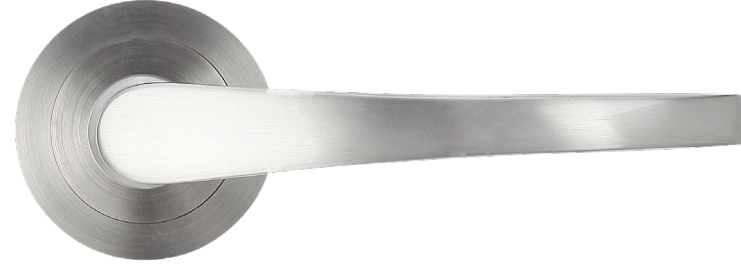

Lever No.
Z007

Item No.
ZQ03Z007

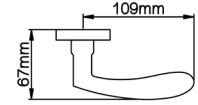

Lever No.
Z008

Item No.
ZQ03Z008

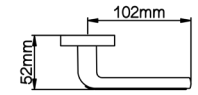



Lever No.
Z009
Item No.
ZQ03Z009

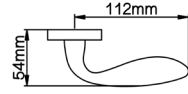

Lever No.
Z010
Item No.
ZQ03Z010

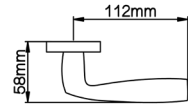

www.advance-hardware.com

www.advance-hardware.com



Lever No.
Z011
Item No.
ZQ03Z011

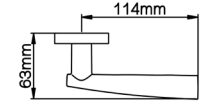

Lever No.
Z012
Item No.
ZQ03Z012

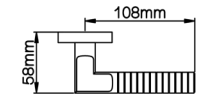
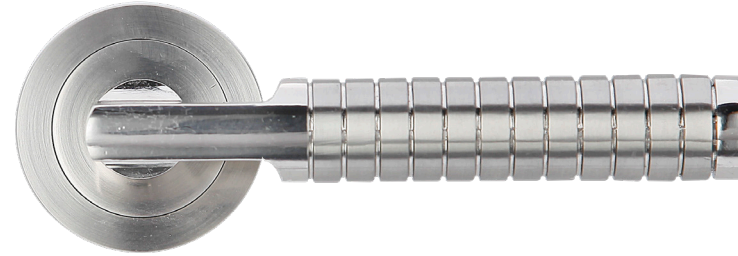



Lever No.
Z013
Item No.
ZQ03Z013

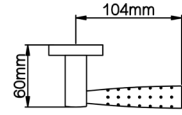

Lever No.
Z014
Item No.
ZQ05Z014

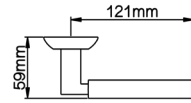

www.advance-hardware.com

www.advance-hardware.com



Lever No.
Z015
Item No.
ZQ05Z015

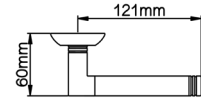

Lever No.
Z016
Item No.
ZQ03Z016

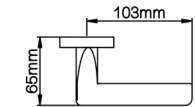



Lever No.
Z017
Item No.
ZQ03Z017

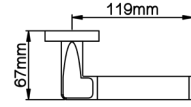

Lever No.
Z018
Item No.
ZQ03Z018

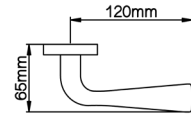

www.advance-hardware.com

www.advance-hardware.com



Lever No.
Z019
Item No.
ZQ05Z019

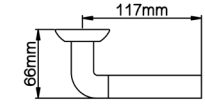

Lever No.
Z020
Item No.
ZQ05Z020

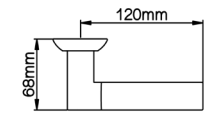



Lever No.
Z021
Item No.
ZQ05Z021

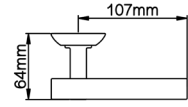

Lever No.
Z022
Item No.
ZQ05Z022

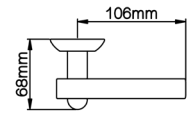

www.advance-hardware.com

www.advance-hardware.com



Lever No.
Z023
Item No.
ZQ05Z023

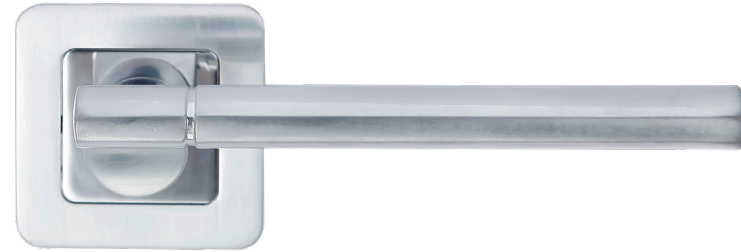
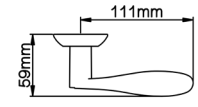

Lever No.
Z024
Item No.
ZQ09Z024

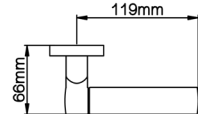



Lever No.
Z025
Item No.
ZQ05Z025

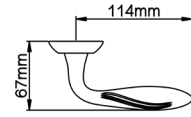

Lever No.
Z026
Item No.
ZQ03Z026

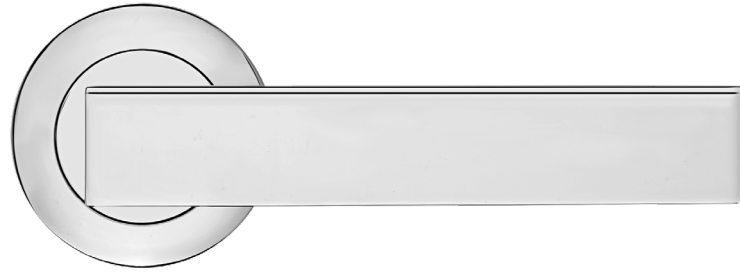
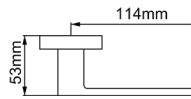

www.advance-hardware.com

www.advance-hardware.com

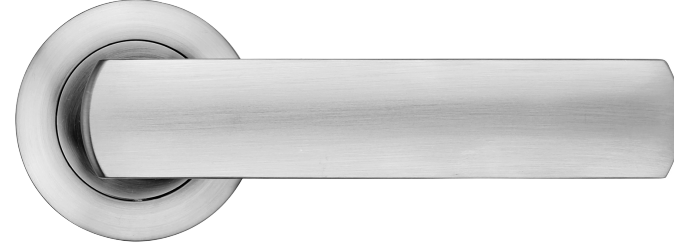

Lever No.
Z027
Item No.
ZQ03Z027

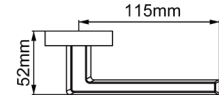

Lever No.
Z028
Item No.
ZQ03Z028

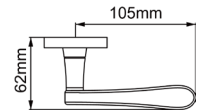

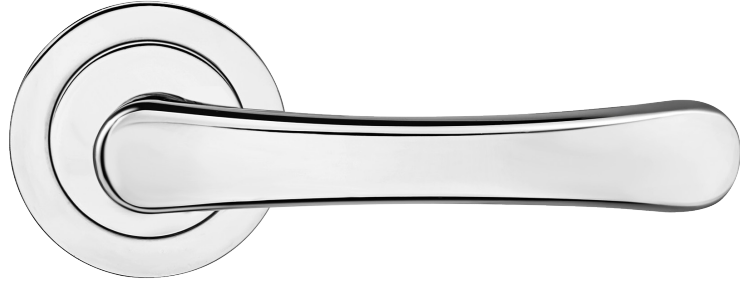

Lever No.
Z029

Item No.
ZQ03Z029

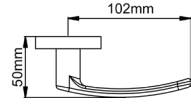

Lever No.
Z030

Item No.
ZQ03Z030

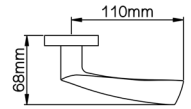

www.advance-hardware.com

www.advance-hardware.com

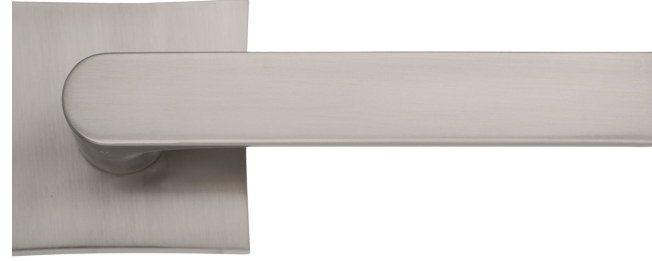

Lever No.
Z032

Item No.
ZQ35Z032

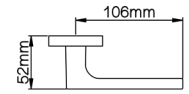

Lever No.
Z034

Item No.
ZQ35Z034

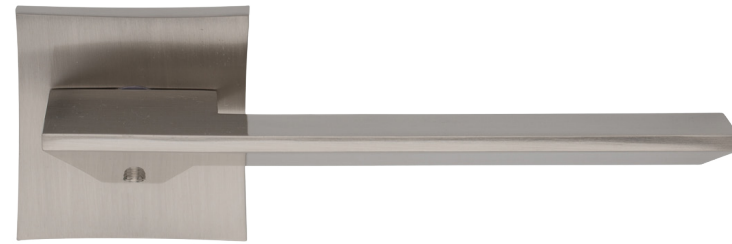
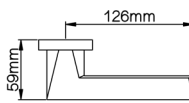



Lever No.
Z035

Item No.
ZQ36Z035

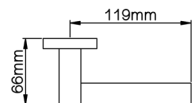

Lever No.
Z036

Item No.
ZQ03Z036

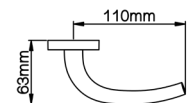

www.advance-hardware.com

www.advance-hardware.com

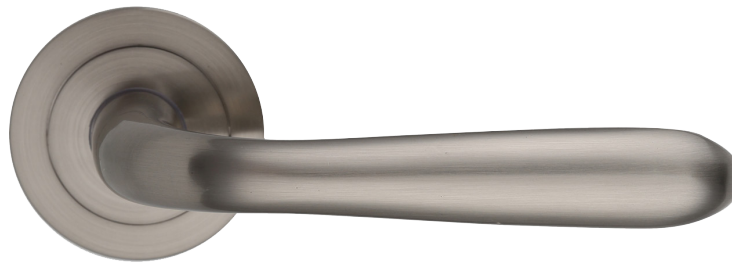

Lever No.
Z037

Item No.
ZQ03Z037

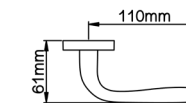

Lever No.
Z039

Item No.
ZQ03Z039

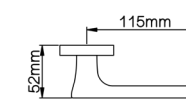



Lever No.

Z087

Item No.

ZQ08Z087

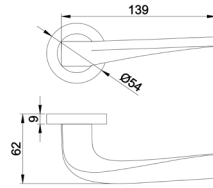

www.advance-hardware.com

www.advance-hardware.com



Lever No.

Z088

Item No.

ZB60Z088+ZC14

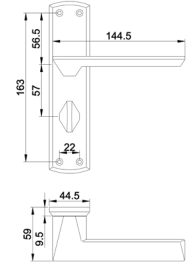



Lever No.
Z045
Item No.
ZQ47Z045

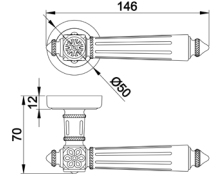

Lever No.
Z046
Item No.
ZQ46Z046

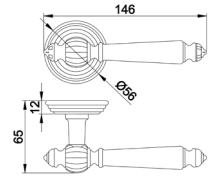

www.advance-hardware.com

www.advance-hardware.com



Lever No.
Z048
Item No.
ZQ48Z048

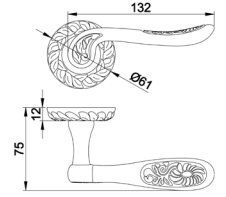

Lever No.
Z049
Item No.
ZQ47Z049

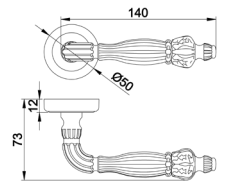



Lever No.
Z050

Item No.
ZQ46Z050

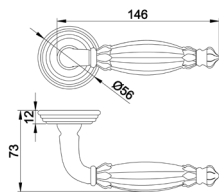

Lever No.
Z052

Item No.
ZQ48Z052

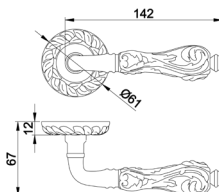

www.advance-hardware.com

www.advance-hardware.com



Lever No.
Z051

Item No.
ZB49Z051

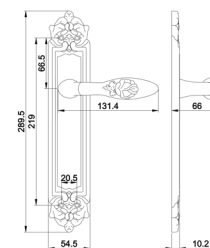

www.advance-hardware.com

www.advance-hardware.com





Lever No.
Z090

Item No.
ZQ69Z090

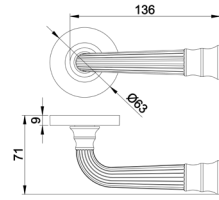

Lever No.
Z091

Item No.
ZQ08Z091

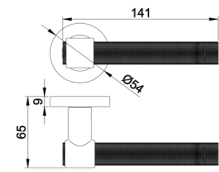

www.advance-hardware.com

www.advance-hardware.com

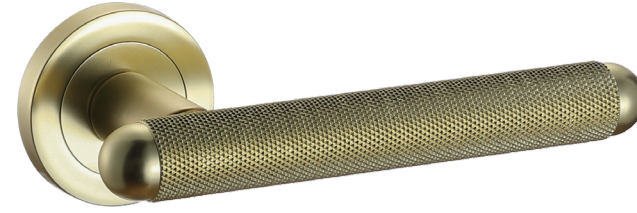

Lever No.
Z092

Item No.
ZQ08Z092

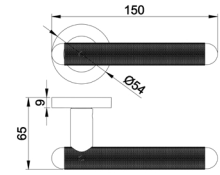



www.advance-hardware.com



Rosete No.
SL02

Diameter & Height
53mm, 8mm

Material
Stainless Steel



Rosete No.
SL21

Length & Height
55mm, 8mm

Material
Stainless Steel



Rosete No.
TL02

Diameter & Height
53mm, 10mm

Material
Steel



Rosete No.
TL03

Diameter & Height
50mm, 10mm

Material
Steel



Rosete No.
ZL03

Diameter & Height
50.5mm, 9.2mm

Material
Zinc



Rosete No.
ZL05

Diameter & Height
53.5mm, 11.5mm

Material
Zinc

www.advance-hardware.com

www.advance-hardware.com



Rosete No.
ZL09

Length & Height
52mm, 9.5mm

Material
Zinc



Rosete No.
ZL26

Diameter & Thickness
36mm, 3.5mm

Material
Zinc



Rosete No.
SY21

Material
Stainless Steel

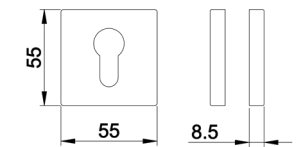

A rosette with different holes

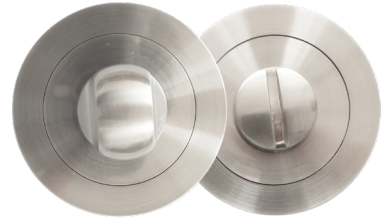

Item No.
ZD03

Hole Style
CD

Item No.
ZL03

Hole Style
CLE

Item No.
ZY03

Hole Style
CYL

www.advance-hardware.com

www.advance-hardware.com



Rosette No.
DMH-60213-5

Material
Stainless Steel

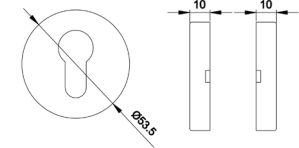

Rosette No.
DMH-60213-7

Material
Stainless Steel

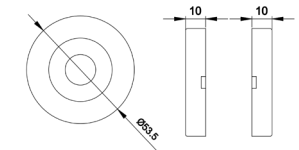

Rosette No.
WC-Ø35

Material
Stainless Steel

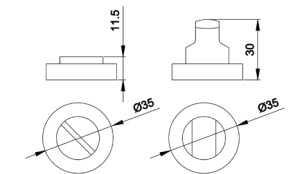



Rosete No.
SD03B

Material
Stainless Steel

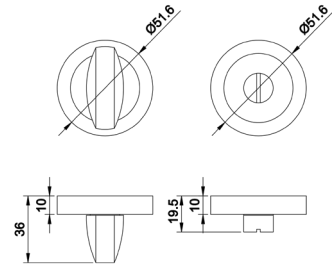

Rosete No.
SL03-JS

Material
Stainless Steel

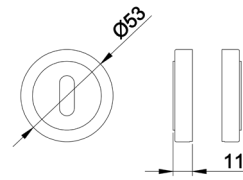

Rosete No.
ZY68

Material
Zinc

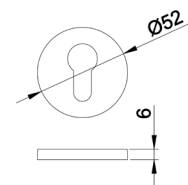

www.advance-hardware.com

www.advance-hardware.com



Rosete No.
DMH-60214-5

Material
Stainless Steel

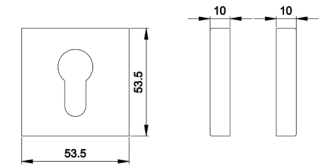

Rosete No.
DMH-60214-7

Material
Stainless Steel

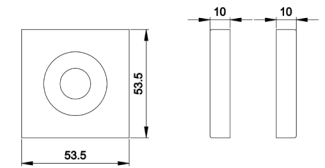

Rosete No.
SL21

Material
Stainless Steel

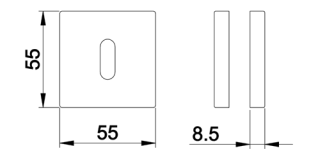





Plate No.
SB07
Material
Stainless Steel

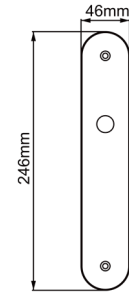
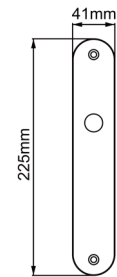

Plate No.
SB08
Material
Stainless Steel



www.advance-hardware.com

www.advance-hardware.com



Plate No.
SB09
Material
Stainless Steel

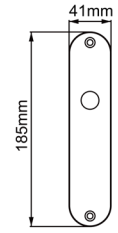

Plate No.
SB19
Material
Stainless Steel

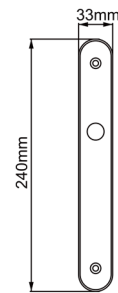



Plate No.
SB20
Material
Stainless Steel

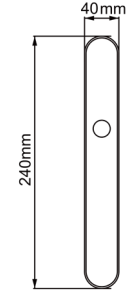
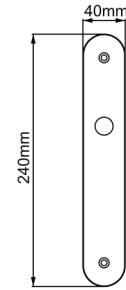

Plate No.
TB04
Material
Steel



www.advance-hardware.com

www.advance-hardware.com



Plate No.
TB05
Material
Steel

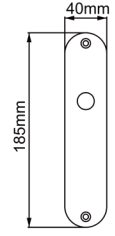

Plate No.
TB07
Material
Steel

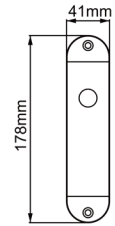



Plate No.
TB12
Material
Steel

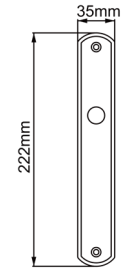
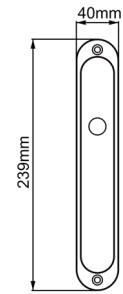

Plate No.
TB15
Material
Steel



www.advance-hardware.com

www.advance-hardware.com



Plate No.
TB16
Material
Steel

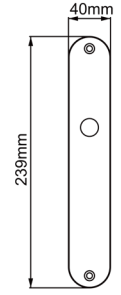

Plate No.
TB17
Material
Steel

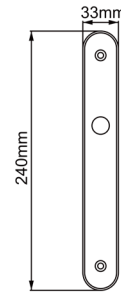



Plate No.
TB18
Material
Steel

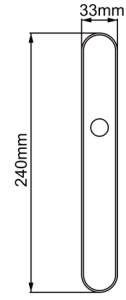
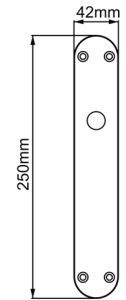

Plate No.
TB20
Material
Steel



www.advance-hardware.com

www.advance-hardware.com



Plate No.
TB21
Material
Steel

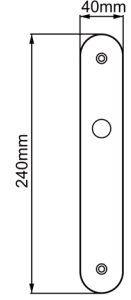

Plate No.
TB22
Material
Steel

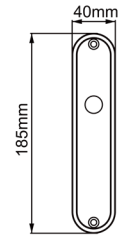



Plate No.
ZB01

Material
Zinc

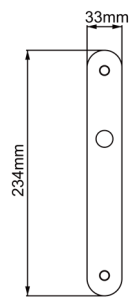
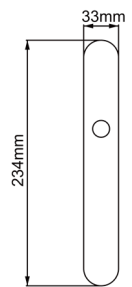

Plate No.
ZB02

Material
Zinc



www.advance-hardware.com

www.advance-hardware.com



Plate No.
ZB06

Material
Zinc

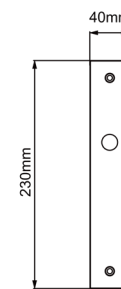

Plate No.
ZB07

Material
Zinc

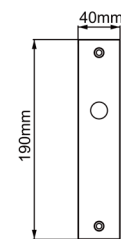



Plate No.
ZB10

Material
Zinc

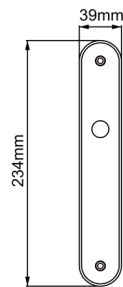
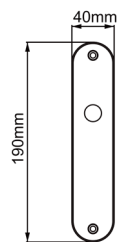

Plate No.
ZB11

Material
Zinc



www.advance-hardware.com

www.advance-hardware.com



Plate No.
ZB13

Material
Zinc

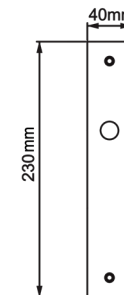

Plate No.
ZB14

Material
Zinc

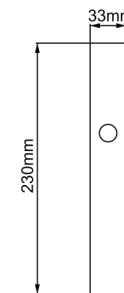
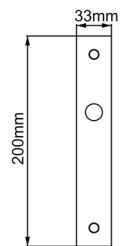



Plate No.
ZB15

Material
Zinc



Item No.
ZD06A002

Hole Style
CD

www.advance-hardware.com

www.advance-hardware.com



Item No.
ZB06A002

Hole Style
BDC



Item No.
ZL06A002

Hole Style
CLE



















































Item No.
ZY06A002

Hole Style
CYL

A rosette with different holes

*Different centre-to-centre distances are available.
(48mm, 57mm, 70mm, 72mm, 68mm, 85mm, 90mm)

 ABH	 ABH-D	 ABM-D	 ACBH-D
 ACH	 ACH-D	 ACM-D	 AIM-D
 AIMD-1	 ASH	 ASH-D	 ASM-D
 BBAE	 BBZ	 BC	 BMN
 BNB	 BNB-D	 BNI	 BNI-D
 BSN	 BSN-D	 CO	 COH
 COH-D	 DBK	 DNI	 DWT
 EABH	 EOA	 HBC	 MC
 MC-L	 MN	 MN-L	 NB
 NB3	 NI-L	 ORB	 ORBH-D
 ORBH-N	 PB	 PC	 RGP
 SB	 SB-D	 SIR	 WT



ADVANCE
CONTACTS

Website:

www.advance-hardware.com

E-mail:

sales@advance-hardware.com

Tel:

+86-571-85155568

Fax:

+86-571-85155443

Headquarters:

1/F Dikuang Building, No. 508
Tiyuchang Road, Hangzhou,
Zhejiang, 310007, P.R. China